



**STRONG PARTNERS.
TOUGH TRUCKS.™**



H40-70FT SERIES TECHNICAL GUIDE

WWW.HYSTER.COM

➤ H40-70FT DIMENSIONS

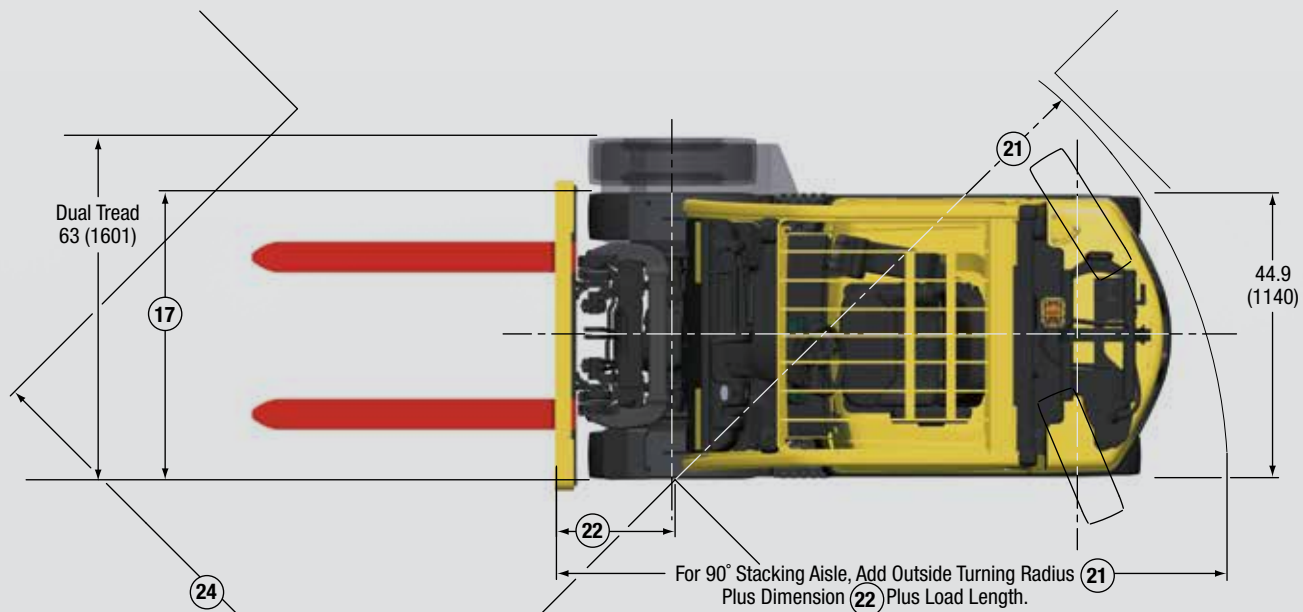

TRUCK MODEL	LIFT CAPACITY	LOAD CENTER	F	G	J	L
	lb (kg)	in (mm)	percent	percent	in (mm)	in (mm)
H40FT	4000 (1814)	24.0 (610)	48%	25.3%	27.6 (702)	15.0 (382)
H50FT	5000 (2268)	24.0 (610)	44%	25.3%	27.6 (702)	15.0 (382)
H60FT	6000 (2721)	24.0 (610)	52%	28.0%	28.6 (727)	16.0 (407)
H70FT	7000 (3175)	24.0 (610)	54%	28.0%	28.6 (727)	16.0 (407)

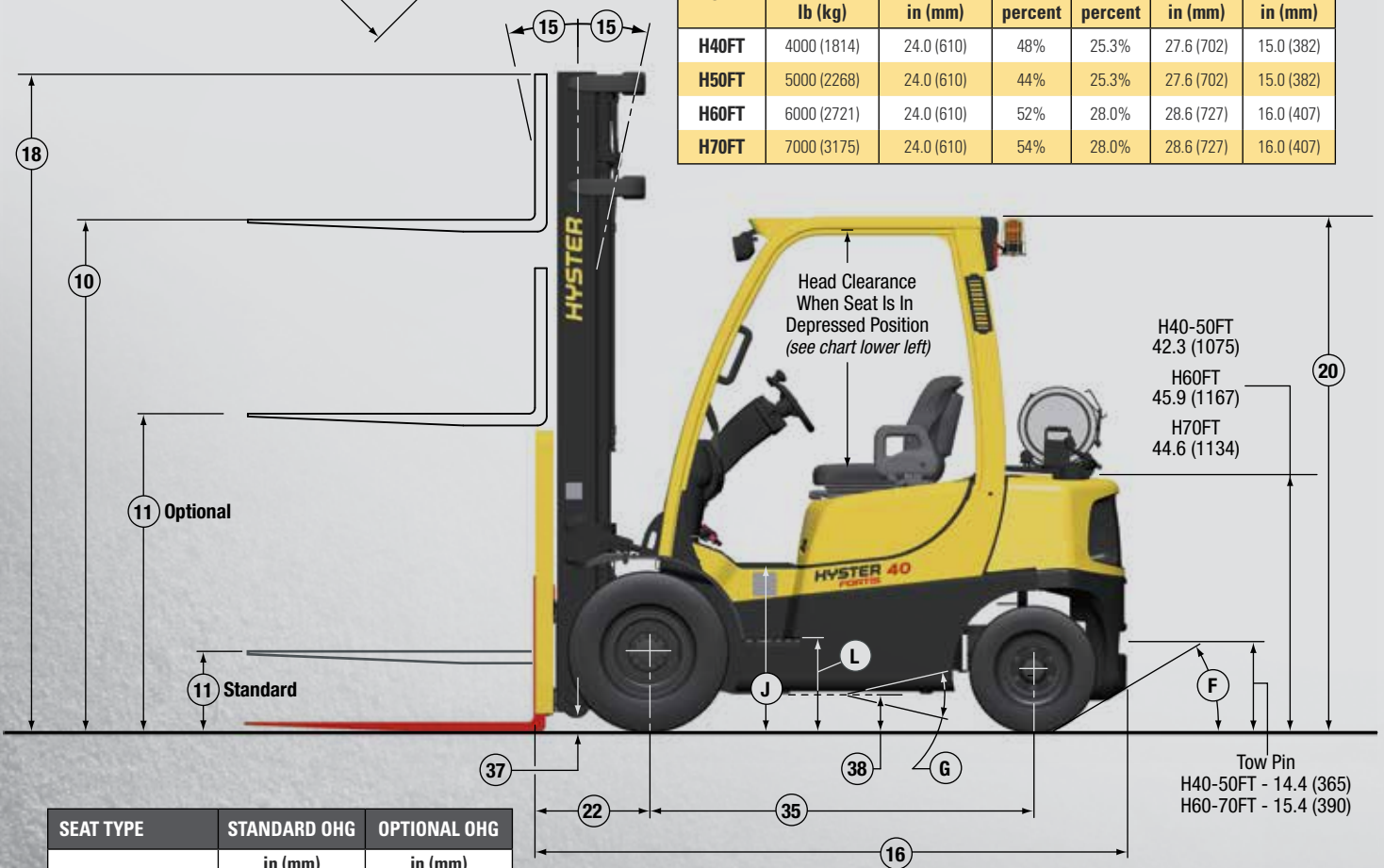

SEAT TYPE	STANDARD OHG	OPTIONAL OHG
	in (mm)	in (mm)
Non-Suspension	42.0 (1067)	39.4 (1001)
Semi-Suspension	42.5 (1079)	39.9 (1013)
Full-Suspension	42.0 (1067)	N/A
Swivel Full-Suspension	41.8 (1061)	N/A

Circled dimensions correspond to the line numbers on the tabulated chart inside the Technical Guide. Dimensions are in inches (millimeters).

H40-50FT SPECIFICATIONS

GENERAL	1	Manufacturer Name	Hyster Company			Hyster Company		
	2	Model	H40FT			H50FT		
		Engine	PSI 2.4L	Kubota 2.5L	Kubota 2.4L Tier 4 Final	PSI 2.4L	Kubota 2.5L	Kubota 2.4L Tier 4 Final
	3	Rated Capacity	4000 (1814)			5000 (2268)		
	4	Load Center, Distance	24.0 (610)			24.0 (610)		
	5	Power Type - LPG, Diesel, Dual Fuel	LPG	Dual Fuel	LPG	Diesel	LPG	Dual Fuel
	6	Operator Type	Sit-Down Rider			Sit-Down Rider		
	7	Step Height	15.0 (382)			15.0 (382)		
	8	Tire Type - Cushion, Solid, Pneumatic	Pneumatic			Pneumatic		
	9	Wheels, Number - Front/ Rear	2x/2			2x/2		
	10	Lift Height, Top of Fork (TOF)	129 (3292)			129 (3292)		
	11	Lift Heights, Std Limited Free Lift (LFL) w/o LBR (TOF)	5 (140)			5 (140)		
		Lift Heights, Opt Full Free Lift (FFL) w/o LBR (TOF)	61 (1565)			61 (1565)		
	12	Standard Carriage Width	42.0 (1067)			42 (1067)		
	13	Forks, Thickness x Width x Length	1.6 X 3.9 X 42			1.6 X 3.9 X 42		
		Forks, Thickness x Width x Length	(40 X 100 X 1067)			(40 X 100 X 1067)		
	14	Fork Spread, Outside Dimensions	43.3 (1099)			43.3 (1099)		
	15	Mast Tilt Angles, Forward/Backward	6F/10B			6F/6B		
	16	Length To Face of Forks	98.0 (2486)			100.7 (2559)		
	17	Overall Width, Standard Tread	45.6 (1157)			45.6 (1157)		
		Overall Width, Wide Tread	51.9 (1317)			51.9 (1317)		
	18	Height, Standard Mast - Lowered	86.0 (2170)			86 (2170)		
	19	Height, Standard Mast - Extended with LBR	147 (3715)			147 (3715)		
		Height, Standard Mast - Extended without LBR	123 (3100)			123 (3100)		
	20	Height, Standard Overhead Guard	85.0 (2160)			85.0 (2160)		
		Height, Optional Overhead Guard	82.4 (2093)			82 (2093)		
	21	Turning Radius, Minimum Outside (OTR)	84.6 (2149)			87.2 (2216)		
	22	Length, Center of Wheel to Face of Forks	18.5 (470)			18.5 (470)		
	23	Aisle Width, Right Angle Stack (Add Length of Load)	103.1 (2619)			105.7 (2686)		
	24	Equal Aisle, 90-Degree Intersecting Aisle	79.5 (1987)			80.6 (2020)		
	25	Travel Speed, Powershift Transmission RL/NL	11.5/11.8 (18.5/19.0)	10.4/10.6 (16.7/17.0)	11.2/11.3 (18.0/18.2)	11.5/11.8 (18.5/19.0)	10.4/10.6 (16.7/17.0)	11.2/11.3 (18.0/18.2)
	26	Lift Speed, Standard 2-Stage LFL RL/NL	120/124 (.61/.63)	122/126 (.62/.64)	122/126 (.62/.64)	120/124 (.61/.63)	122/126 (.62/.64)	122/126 (.62/.64)
		Lift Speed, Optional 2-Stage FFL RL/NL	106/110 (.54/.56)	106/112 (.54/.57)	106/112 (.54/.57)	106/110 (.54/.56)	108/112 (.55/.57)	106/112 (.54/.57)
		Lift Speed, Optional 3-Stage FFL RL/NL	112/116 (.57/.59)	114/120 (.58/.61)	114/120 (.58/.61)	112/116 (.57/.59)	114/120 (.58/.61)	114/120 (.58/.61)
	27	Lowering Speed, Standard 2-Stage LFL RL/NL	114/98 (.58/.50)			114/98 (.58/.50)		
		Lowering Speed, Optional 2-Stage FFL RL/NL	98/83 (.50/.42)			98/83 (.50/.42)		
		Lowering Speed, Optional 3-Stage FFL RL/NL	106/93 (.54/.47)			106/93 (.54/.47)		
	28	Maximum drawbar pull RL/NL	4980/2315 (2259/1050)	5018/2315 (2276/1050)	5180/2315 (2350/1050)	4952/2249 (2246/1020)	4989/2249 (2263/1020)	5150/2249 (2340/1020)
		Drawbar Pull, Standard Transmission @ 1 mph RL/NL	4215/2315 (1912/1050)	4297/2315 (1949/1050)	4760/2315 (2160/1050)	4184/2249 (1898/1020)	4268/2249 (1936/1020)	4730/2249 (2150/1020)
	29	Gradeability, Standard Transmission @ 1 mph RL/NL	37/32			32/28		
	31	Weight, Standard Truck (2-Stg. LFL) NL	7654 (3472)			8399 (3810)		
		Weight, Standard Truck (2-Stg. LFL) RL	11655 (5286)			13399 (6078)		
	32	Axle Loading, Static Front/Rear NL	3929/3725 (1782/1690)			3776 /4623 (1713/2097)		
		Axle Loading, Static Front/Rear RL	10593/1062 (4805/482)			12105/1294 (5491/587)		
	33	Tire Size, Front	7.00 x 12 - 12			7.00 x 12 - 12		
	34	Tire Size, Rear	6.00 x 9			6.00 x 9		
	35	Wheelbase	63.9 (1623)			63.9 (1623)		
	37	Ground Clearance, Lowest Point NL (w/RL subtract-6mm)	5.2 (132)			5.2 (132)		
	38	Ground Clearance, Center of Wheelbase NL	6.3 (160)			6.3 (160)		
	39	Service Brake - Method of Control/Operation	Foot/Hydraulic			Foot/Hydraulic		
	40	Parking Brake - Method of Control/Operation	Hand/Mechanical			Hand/Mechanical		
	41	Battery Type	Maintenance Free			Maintenance Free		
	42	Volts/Cold Cranking Amps	12/475			12/770		
	43	Engine, Manufacturer/Model	PSI 2.4L	Kubota 2.5L	Kubota 2.4L	PSI 2.4L	Kubota 2.5L	Kubota 2.4L
	44	Permanent Output @ Rated RPM	59 (44) @ 2700	59 (44) @ 2700	57 (43) @ 2400	59 (44) @ 2700	59 (44) @ 2700	57 (43) @ 2400
	45	Torque @ Rated RPM	121 (16.7) @ 2000	131 (18) @ 1000	146 (20) @ 1500	121 (16.7) @ 2000	131 (18) @ 1000	146 (20) @ 1500
	46	Number of Cylinders/Displacement	4/2351 (143)			4/2491 (152)		
	47	Transmission Type, Standard	Electronic Powershift			Electronic Powershift		
		Standard Speeds, Forward - Reverse	1-1			1-1		
	49	Hydraulic Tank Capacity (Drain and Refill)	12.1 (45.8)			12.1 (45.8)		
	50	Fuel Tank Capacity (Gas & Diesel Powered Units Only)	13.9 (52.8)			13.9 (52.8)		
	51	Auxiliary Hydraulic Pressure Relief for Attachments	PSI (Mpa)			2250 (15.5)		

RL = Rated Load NL = No Load

NOTE: Above specifications, unless otherwise listed, are for a standard truck without optional equipment. Right Angle Stack and Equal Intersecting Aisle are calculated using a 40" wide pallet.

NOTE: Performance specifications / ratings are for truck equipped as described under Standard Equipment in this Technical Guide. Performance specifications are affected by the condition of the vehicle and how it is equipped, as well as by the nature and condition of the operating area. Specifications are subject to change and the proposed application should be discussed with your authorized Hyster Company Dealer.

CERTIFICATION: Hyster lift trucks meet the design and construction requirements of B56.1-1969, per OSHA Section 1910.178(a)(2), and also comply with the B56.1 revision in effect at time of manufacture.

Certification of compliance with the applicable ANSI standards appears on the lift truck.

H60-70FT SPECIFICATIONS

GENERAL	1	Manufacturer Name	Hyster Company			Hyster Company					
	2	Model	H60FT			H70FT					
		Engine	PSI 2.4L	Kubota 2.5L	Kubota 2.4L Tier 4 Final	PSI 2.4L	Kubota 2.5L	Kubota 2.4L Tier 4 Final			
DIMENSIONS	3	Rated Capacity	6000 (2722)			7000 (3175)					
	4	Load Center, Distance	24.0 (610)			24.0 (610)					
	5	Power Type - LPG, Diesel, Dual Fuel	LPG	Dual Fuel	LPG	Diesel	LPG	Dual Fuel	LPG	Diesel	
	6	Operator Type	Sit-Down Rider			Sit-Down Rider					
	7	Step Height	16 (407)			16.0 (407)					
	8	Tire Type - Cushion, Solid, Pneumatic	Pneumatic			Pneumatic					
	9	Wheels, Number - Front/ Rear	2x/2			2x/2					
	10	Lift Height, Top of Fork (TOF)	126 (3209)			126 (3209)					
	11	Lift Heights, Std Limited Free Lift (LFL) w/o LBR (TOF)	5 (140)			5 (140)					
		Lift Heights, Opt Full Free Lift (FFL) w/o LBR (TOF)	58 (1490)			58 (1490)					
	12	Standard Carriage Width	42 (1067)			42 (1067)					
	13	Forks, Thickness x Width x Length	2.0 X 4.9 X 42			2.0 X 4.9 X 42					
		Forks, Thickness x Width x Length	(50 X 125 X 1067)			(50 X 125 X 1067)					
	14	Fork Spread, Outside Dimensions	43.3 (1099)			43.3 (1099)					
	15	Mast Tilt Angles, Forward/Backward	6F/6B			6F/6B					
	16	Length To Face of Forks	103.4 (2625)			107.6 (2734)					
	17	Overall Width, Standard Tread	46.7 (1186)			46.7 (1186)					
		Overall Width, Wide Tread	52.0 (1321)			52.0 (1321)					
	18	Height, Standard Mast - Lowered	89 (2245)			89 (2245)					
	19	Height, Standard Mast - Extended with LBR	175 (4330)			175 (4330)					
		Height, Standard Mast - Extended without LBR	154 (3905)			154 (3905)					
	20	Height, Standard Overhead Guard	86.0 (2185)			86 (2185)					
		Height, Optional Overhead Guard	83 (2118)			83 (2118)					
	21	Turning Radius, Minimum Outside (OTR)	89.6 (2277)			93.7 (2380)					
22	Length, Center of Wheel to Face of Forks	18.9 (480)			18.9 (480)						
23	Aisle Width, Right Angle Stack (Add Length of Load)	108.5 (2757)			112.6 (2860)						
24	Equal Aisle, 90-Degree Intersecting Aisle	82.8 (2077)			84 (2111)						
PERFORMANCE	25	Travel Speed, Powershift Transmission RL/NL	mph (km/h)	11.8/12.4 (19.0/20.0)	11.1/11.3 (17.8/18.2)	11.9/12.1 (19.2/19.5)	11.8/12.4 (19.0/20.0)	11.1/11.3 (17.8/18.2)	11.9/12.1 (19.2/19.5)		
	26	Lift Speed, Standard 2-Stage LFL RL/NL	ft/min (m/s)	104/108 (.53/.55)	108/110 (.55/.56)	108/110 (.55/.56)	104/108 (.53/.55)	110/110 (.56/.56)	110/110 (.56/.56)		
		Lift Speed, Optional 2-Stage FFL RL/NL	ft/min (m/s)	102/102 (.52/.52)	104/106 (.53/.54)	104/106 (.53/.54)	102/102 (.52/.52)	104/106 (.53/.54)	104/106 (.53/.54)		
		Lift Speed, Optional 3-Stage FFL RL/NL	ft/min (m/s)	100/104 (.51/.53)	100/104 (.51/.53)	100/104 (.51/.53)	100/104 (.51/.53)	102/104 (.52/.53)	102/104 (.52/.53)		
	27	Lowering Speed, Standard 2-Stage LFL RL/NL	ft/min (m/s)	104/93 (.53/.47)			104/93 (.53/.47)				
		Lowering Speed, Optional 2-Stage FFL RL/NL	ft/min (m/s)	98/83 (.50/.42)			98/83 (.50/.42)				
		Lowering Speed, Optional 3-Stage FFL RL/NL	ft/min (m/s)	114/87 (.58/.44)			114/87 (.58/.44)				
	28	Maximum drawbar pull RL/NL	lb (kg)	4497/2346 (2040/1064)	4530/2346 (2055/1064)	4680/2346 (2120/1064)	4465/2317 (2025/1051)	4500/2317 (2041/1051)	4650/2317 (2110/1051)		
		Drawbar Pull, Standard Transmission @ 1 mph RL/NL	lb (kg)	3845/2346 (1744/1064)	3920/2346 (1778/1064)	4330/2346 (1960/1064)	3810/2317 (1730/1051)	3887/2317 (1763/1051)	4300/2317 (1950/1051)		
	29	Gradeability, Standard Transmission @ 1 mph RL/NL	Percent %	25/26	26/26	27/26	22/24	23/24	24/24		
WT.	31	Weight, Standard Truck (2-Stg. LFL) NL	lb (kg)	9943 (4510)			10357 (4698)				
		Weight, Standard Truck (2-Stg. LFL) RL	lb (kg)	15943 (7232)			17356 (7873)				
	32	Axle Loading, Static Front/Rear NL	lb (kg)	3865/6077 (1753/2757)			3810/6547 (1728/2970)				
		Axle Loading, Static Front/Rear RL	lb (kg)	13905/2038 (6307/924)			15304/2052 (6942/931)				
TIRES & WHEELS	33	Tire Size, Front	28 x 9 - 15			28 x 9 - 15					
	34	Tire Size, Rear	6.50 x 10			6.50 x 10					
	35	Wheelbase	in (mm)	63.9 (1623)			66.9 (1700)				
	37	Ground Clearance, Lowest Point NL (w/RL subtract-6mm)	in (mm)	6.2 (157)			6.2 (157)				
	38	Ground Clearance, Center of Wheelbase NL	in (mm)	6.3 (160)			7.3 (185)				
	39	Service Brake - Method of Control/Operation	Foot/Hydraulic			Foot/Hydraulic					
	40	Parking Brake - Method of Control/Operation	Hand/Mechanical			Hand/Mechanical					
	41	Battery Type	Maintenance Free			Maintenance Free					
POWERTRAIN	42	Volts/Cold Cranking Amps	vcca	12/475		12/770		12/475		12/770	
	43	Engine, Manufacturer/Model		PSI 2.4L	Kubota 2.5L	Kubota 2.4L	PSI 2.4L	Kubota 2.5L	Kubota 2.4L		
	44	Permanent Output @ Rated RPM	hp (kw)	59 (44) @ 2700	59 (44) @ 2700	57 (43) @ 2400	59 (44) @ 2700	59 (44) @ 2700	57 (43) @ 2400		
	45	Torque @ Rated RPM	ft Lbs (kg/m)	121 (16.7) @ 2000	131 (18) @ 1000	146 (20) @ 1500	121 (16.7) @ 2000	131 (18) @ 1000	146 (20) @ 1500		
	46	Number of Cylinders/Displacement	No/cc (ci)	4/2351 (143)	4/2491 (152)	4/2434 (149)	4/2351 (143)	4/2491 (152)	4/2434 (149)		
	47	Transmission Type, Standard	Electronic Powershift			Electronic Powershift					
		Standard Speeds, Forward - Reverse	1-1			1-1					
	49	Hydraulic Tank Capacity (Drain and Refill)	gal (liter)	12.1 (45.8)			12.1 (45.8)				
	50	Fuel Tank Capacity (Gas & Diesel Powered Units Only)	gal (liter)	13.9 (52.8)			13.9 (52.8)				
	51	Auxiliary Hydraulic Pressure Relief for Attachments	PSI (Mpa)	2250 (15.5)			2250 (15.5)				

RL = Rated Load NL = No Load

NOTE: Above specifications, unless otherwise listed, are for a standard truck without optional equipment. Right Angle Stack and Equal Intersecting Aisle are calculated using a 40" wide pallet.

NOTE: Performance specifications / ratings are for truck equipped as described under Standard Equipment in this Technical Guide. Performance specifications are affected by the condition of the vehicle and how it is equipped, as well as by the nature and condition of the operating area. Specifications are subject to change and the proposed application should be discussed with your authorized Hyster Company Dealer.

CERTIFICATION: Hyster lift trucks meet the design and construction requirements of B56.1-1969, per OSHA Section 1910.178(a)(2), and also comply with the B56.1 revision in effect at time of manufacture.

Certification of compliance with the applicable ANSI standards appears on the lift truck.

H40-70FT MAST SPECIFICATIONS

H40-50FT MAST DIMENSIONS							
Maximum Fork Height (TOF) †	Overall Lowered Height	Overall Extended Height		Free Lift (TOF)		Approximate Total Weight of Standard Equipped Truck	
		with LBR	without LBR	with LBR	without LBR	H40FT	H50FT
in (mm)	in (mm)	in (mm)	in (mm)	in (mm)	in (mm)	lbs (kg)	lbs (kg)
2-STAGE LIMITED FREE LIFT (LFL) VISTA™ PLUS MAST							
129 (3292)	86 (2170)	178 (4515)	123 (3100)	5 (140)	5 (140)	7654 (3472)	8399 (3810)
2-STAGE FULL FREE LIFT (FFL) VISTA™ MAST							
130 (3302)	86 (2170)	179 (4525)	154 (3910)	37 (950)	61 (1565)	7692 (3489)	8437 (3827)
3-STAGE FULL FREE LIFT (FFL) VISTA™ PLUS MAST							
171 (4350)	78 (1970)	220 (5570)	195 (4935)	29 (750)	54 (1390)	7934 (3599)	8679 (3937)
189 (4800)	84 (2120)	237 (6020)	213 (5385)	35 (900)	60 (1540)	8012 (3634)	8757 (3972)
194 (4950)	86 (2170)	243 (6170)	218 (5535)	37 (950)	62 (1590)	8037 (3645)	8782 (3983)
200 (5100)	90 (2270)	249 (6320)	224 (5685)	41 (1050)	66 (1690)	8083 (3666)	8828 (4004)
218 (5550)	96 (2420)	267 (6770)	242 (6135)	47 (1200)	72 (1840)	8165 (3704)	8910 (4042)

H60-70FT MAST DIMENSIONS							
Maximum Fork Height (TOF) †	Overall Lowered Height	Overall Extended Height		Free Lift (TOF)		Approximate Total Weight of Standard Equipped Truck	
		with LBR	without LBR	with LBR	without LBR	H60FT	H70FT
in (mm)	in (mm)	in (mm)	in (mm)	in (mm)	in (mm)	lbs (kg)	lbs (kg)
2-STAGE LIMITED FREE LIFT (LFL) VISTA™ PLUS MAST							
126 (3209)	89 (2245)	175 (4430)	154 (3905)	5 (150)	5 (150)	9943 (4510)	10357 (4698)
2-STAGE FULL FREE LIFT (FFL) VISTA™ MAST							
122 (3110)	87 (2195)	171 (4335)	150 (3805)	37 (965)	59 (1500)	9957 (4516)	10371 (4704)
130 (3310)	91 (2295)	179 (4535)	158 (4005)	38 (975)	63 (1600)	9994 (4533)	10408 (4721)
3-STAGE FULL FREE LIFT (FFL) VISTA™ PLUS MAST							
181 (4618)	87 (2195)	230 (5840)	208 (5260)	37 (965)	63 (1600)	10307 (4675)	10721 (4863)
187 (4768)	91 (2295)	236 (5990)	213 (5410)	41 (1065)	65 (1655)	10352 (4696)	10766 (4883)
211 (5368)	101 (2545)	260 (6590)	237 (6010)	51 (1315)	75 (1905)	10481 (4754)	10894 (4942)
228 (5818)	107 (2695)	278 (7040)	256 (6495)	57 (1465)	80 (2055)	10662 (4836)	11076 (5024)

† Lift heights over 171.5" (4356 mm) maximum fork height are considered highlifts and require reduced capacity and restricted back tilt. Total approximate weights listed include mast, standard carriage, load backrest (LBR) and 70 lbs. LPG tank and tank bracket.

➤ H40-70FT RATED CAPACITIES

RATED LOAD vs. LOAD CENTER
STANDARD CARRIAGE
U. S. CUSTOMARY

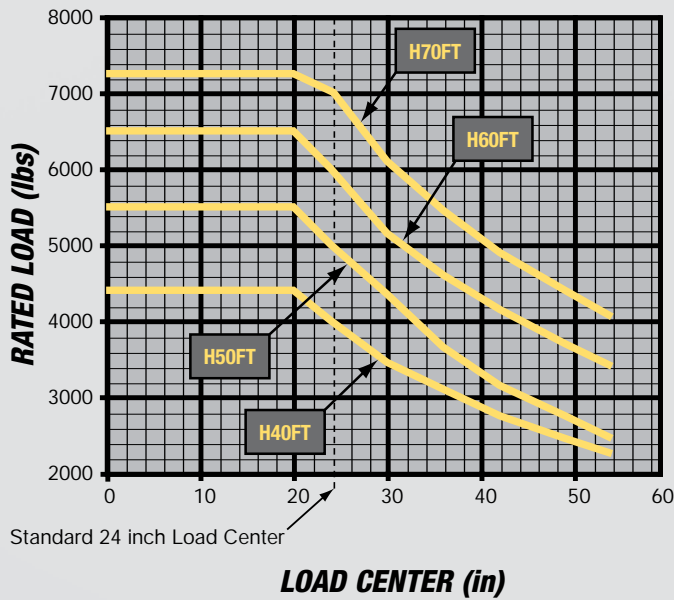

RATED LOAD vs. LOAD CENTER
INTEGRAL SIDESHIFT ATTACHMENT
U. S. CUSTOMARY

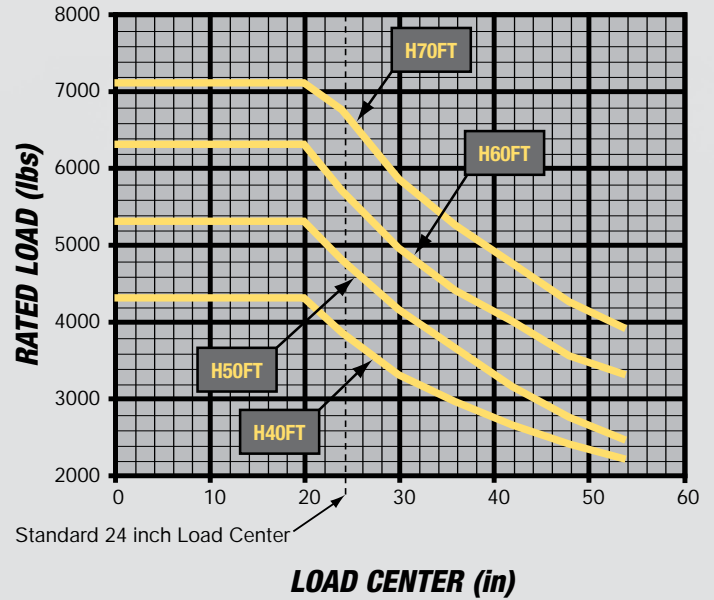

RATED LOAD vs. LOAD CENTER
STANDARD CARRIAGE
METRIC

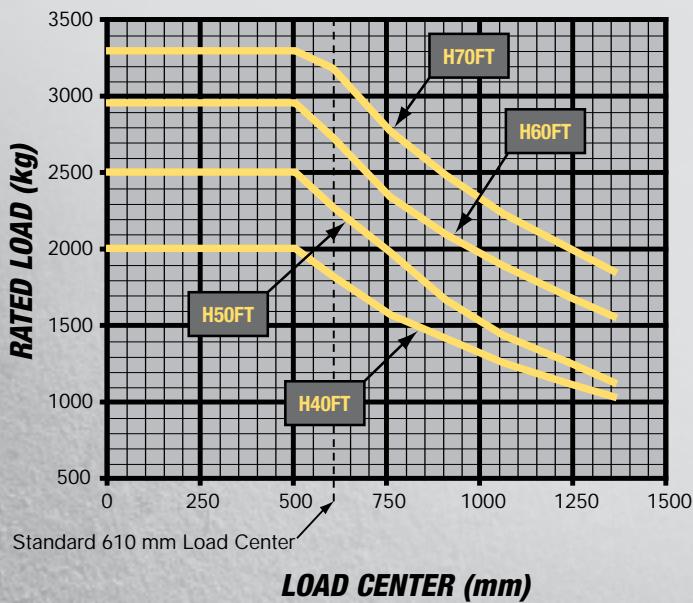

RATED LOAD vs. LOAD CENTER
INTEGRAL SIDESHIFT ATTACHMENT
METRIC

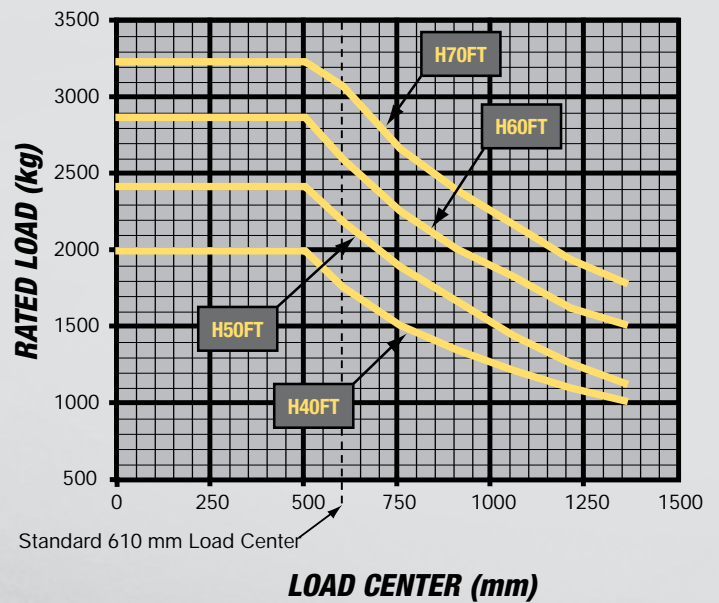

TRUCK CONFIGURATION:

- 3-stage FFL mast at highest non-highlift (HNHL) 171.0" (4350 mm) maximum fork height (MFH) for H40-50FT and 164.0" (4170 mm) for H60-70FT.
- 42.0" (1067 mm) standard carriage with load backrest (LBR).
- Basic truck equipped with the PSI 2.4L LPG engine with one-speed electronic powershift transmission.

STANDARD EQUIPMENT

PSI 2.4L LPG engine
 Neutral start switch
 Anti-restart protection
 Electronic powershift transmission

- Electronic inching
- Electronic shift control

 MONOTROL® pedal
 2-stage limited free lift (LFL) VISTA™ mast with maximum fork height of 129" (3277 mm) (H40-50FT) or 126" (3209 mm) (H60-70FT)
 42" (1067 mm) wide hook-type carriage with 48" (1219 mm) tall load backrest
 42" (1067 mm) long forks
 6 degrees forward / 6 degrees backward mast tilt
 3-function hydraulic control valve
 Integrated dashboard display includes:

- LCD Display:
 - Fuel level (gasoline and diesel)
 - Hour meter
 - Coolant temperature
 - Clock
 - Messages
- Service/Operational Indicator Lights:
 - Alternator
 - Transmission oil temperature
 - Engine oil pressure
 - Brake fluid level
 - Fasten seat belt
 - Low fuel level
 - Engine malfunction
 - System malfunction
 - Park brake
 - Coolant temp
 - Forward, reverse and neutral direction indicators

 Hydrostatic power steering
 Non-suspension vinyl seat
 Electronic horn
 Adjustable steer column
 Rubber floor mat
 High air intake
 Integral tie downs
 Operator restraint system
 Anti-clog radiator
 Single pedal inch brake
 Hyster Stability System (HSS®)
 Cowl-mounted hydraulic control levers
 Swing-out LPG tank bracket
 86" (2185 mm) overhead guard (H40-50FT)
 87" (2210 mm) overhead guard (H60-70FT)
 12 months / 2,000 hours manufacturer's warranty
 36 months / 6,000 hours manufacturer's powertrain warranty
 Operator's manual
 UL Classification LP

OPTIONAL EQUIPMENT

PSI 2.4L dual fuel engine
 Kubota 2.5L LPG engine
 Kubota 2.4L Tier 4 Final turbo diesel engine
 DuraMatch™ transmission

- Auto Deceleration System
- Controlled power reversal feature
- Controlled rollback on ramps

 Powertrain protection system
 Premium electronic monitoring
 High air intake with precleaner
 Accumulator
 Keyless start (with auxiliary key switch)
 Drive and rear halogen or LED work lights
 Oil-cooled wet disc brakes
 Heavy duty anti-clog radiator
 Heavy duty radiator with combi-cooler
 Powertrain protection system
 Paper applications kit
 Vented hood
 Swing-out, drop-down EZXchange LPG tank bracket
 TouchPoint electro-hydraulic controls
 Return-to-set tilt
 Rear drive handle with horn button
 Semi-suspension seat – vinyl or cloth
 Full-suspension seat – vinyl or cloth
 Swivel full-suspension seat – vinyl or cloth
 High-visibility non-cinch seat belt with or without interlock
 Polycarbonate overhead guard rain top
 Impact monitor
 Integral sideshifting fork positioner
 Load weight display
 Operator pre-shift checklist
 Dual inch brake pedals
 Dual side view mirrors
 Password protection
 Audible alarm - reverse activated 82-102 dB(A) self-adjusting
 Visible alarm amber strobe light - continuous activated, overhead guard mounted
 Various light packages

- Two LED brake/back-up lights
- Two halogen or LED front and one rear work lights
- Two front, one rear work light and two LED brake/tail/back-up lights

 High intensity LED lights (brake/tail/back-up)
 Heavy duty anti-clog radiator
 Integral sideshifter
 UL Classification G, GS, D, LPS or DS



Hyster Company
P.O. Box 7006
Greenville, North Carolina
27835-7006
Part No. H40-70FT/TG
4/2017 Litho in U.S.A.

Visit us online at www.hyster.com or call us at **1-800-HYSTER-1**.

Hyster, , and STRONG PARTNERS. TOUGH TRUCKS. and MONOTROL are registered trademarks in the United States and certain other jurisdictions. Hyster products are subject to change without notice.

Trucks may be shown with optional equipment. © 2017 Hyster Company. All rights reserved.